

THIS COPY IS PROVIDED ON A RESTRICTED BASIS AND IS NOT TO BE USED IN ANY WAY DETRIMENTAL TO THE INTERESTS OF PANDUIT CORP.

| PART#        | DESCRIPTION   | WEIGHT*                             |
|--------------|---|-------------------------------------|
| CJSK5E88TG** | 8 POSITION, 8 WIRE SHIELDED MODULE WITH INTEGRAL SHIELD. TERMINATION CAP IS COLOR CODED FOR T568A AND T568B WIRING SCHEMES. | 3.314 LB/100 PCS<br>(1503g/100 PCS) |

\*WEIGHT IS APPROXIMATE  
\*\* = JACK COLOR/KEY SUFFIX  
(SEE SHEET 2)

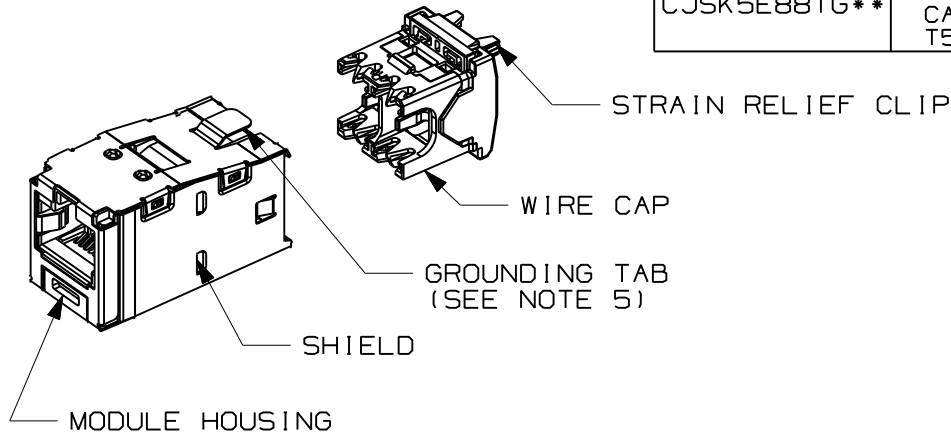

NOTES:

1. RED WIRE CAP DESIGNATES CATEGORY 5e PERFORMANCE.
2. MATERIAL:  
MODULE HOUSING-ABS  
NOMINAL WALL THICKNESS .078(2.0).  
WIRE CAP-PC/ZINC
3. ALL MINI-COM TX5E 8 POSITION, 8 WIRE, KEYED JACK MODULES ARE NOT UNIVERSAL IN DESIGN. EACH MODULE ACCEPTS ONLY ONE SPECIFIC KEYED PLUG THAT MATCHES THE JACK KEYED CONFIGURATION.
4. DIMENSIONS IN PARENTHESES ARE IN METRIC.
5. .187 x .010" GROUNDING TAB PROVIDED AS OPTIONAL CONDUCTIVE PATH FOR GROUNDING.

KEYED FEATURE  
(SEE SHEET 2)

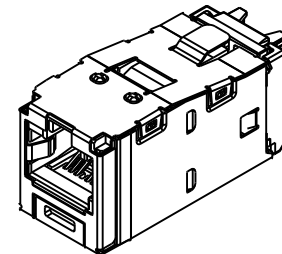
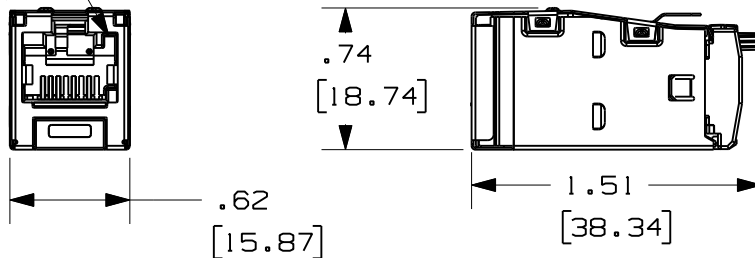

|   |   |                        |   |
|---|---|------------------------|---|
| MODEL FILENAME  | M03011AA/01   | SIZE                   | A                                       |
| DRAWING FILENAME  | M03011EJ_DC59/00B   |                        |   |
| TITLE   | MINI-COM TX5e SHIELDED KEYED JACK MODULE CUSTOMER DRAWING |                        |   |
|   | PANDUIT <sup>TM</sup> CORP.<br>TINLEY PARK, ILL 60477     | I.T. NUMBER            |   |
|   | THIRD ANGLE PROJECTION                                    | PRODUCT SPEC           |   |
| ALL DIMENSIONS ARE GIVEN IN INCHES, UNLESS OTHERWISE SPECIFIED.                   |   | WORK INSTRUCTION       |   |
| DIMENSIONAL TOLERANCES ARE:<br>(.X) ± (.XXX) ±.010(.3)<br>(.XX) ±.03(.8) ANGLES ± |   | SCALE                  | FULL                                    |
| DRAWN BY  | MDJr  | REVIEW DRAWING NUMBERS | PART NO.<br>CJSK5E88TG**                |
| DATE  | 10-22-08  |                        | DRAWING NO.<br>03011-59<br>SHEET 1 OF 2 |
| CHK'D   | BMBA  |                        |   |

| REV | DATE     | BY   | CHK  | DESCRIPTION                        | ECN      | R | CUST | SUP | OTH |
|-----|----------|------|------|------------------------------------|----------|---|------|-----|-----|
| I   | 1-27-09  | MDJr | PBD  | A. UPDATED JACK MODELS ON SHEET 2. | 03011-59 |   |      | VMB |     |
| R   | 12-03-08 | MDJr | BMBA | RELEASED TO PRODUCTION             | 03011-59 |   |      | VMB |     |

**△ SHIELDED JACK COLOR/KEY CODE AND PART NUMBER**

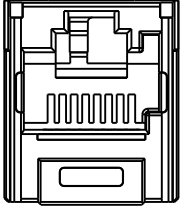
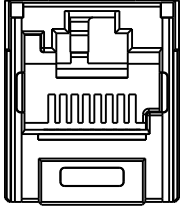
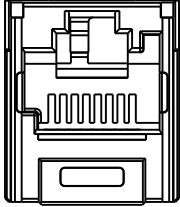
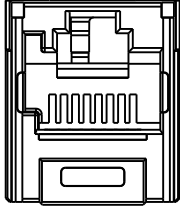
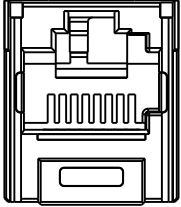
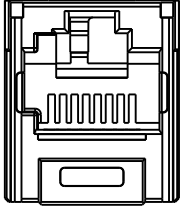
|  |  |   |   |   |   |
|--|--|---|---|---|---|
| <p>A - BLACK</p>  <p>CJSK5E88TGBL</p> | <p>B - RED</p>  <p>CJSK5E88TGRD</p> | <p>C - GREEN</p>  <p>CJSK5E88TGGR</p> | <p>D - YELLOW</p>  <p>CJSK5E88TGYL</p> | <p>E - ORANGE</p>  <p>CJSK5E88TGOR</p> | <p>F - BLUE</p>  <p>CJSK5E88TGBU</p> |
|--|--|---|---|---|---|

| REV | DATE     | BY   | CHK  | DESCRIPTION               | ECN      | R | CUST | SUP | OTH |
|-----|----------|------|------|---------------------------|----------|---|------|-----|-----|
| I   | 1-27-09  | MDJr | PBD  | SEE SHEET ONE FOR CHANGES | 03011-59 |   | VMB  |     |     |
| R   | 12-03-08 | MDJr | BMBA | SEE SHEET ONE FOR CHANGES | 03011-59 |   | VMB  |     |     |

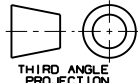
|  |   |                          |
|--|---|--------------------------|
| MODEL FILENAME<br>M03011AA/01  |   | SIZE<br><b>A</b>         |
| DRAWING FILENAME<br>M03011EJ_DC59/00B  |   |                          |
| TITLE<br>MINI-COM TX5e SHIELDED KEYED JACK MODULE CUSTOMER DRAWING   |   |                          |
|   | I.I. NUMBER<br>PRODUCT SPEC             |                          |
|  | WORK INSTRUCTION<br>SCALE<br>FULL       |                          |
| ALL DIMENSIONS ARE GIVEN IN INCHES, UNLESS OTHERWISE SPECIFIED.<br>DIMENSIONAL TOLERANCES ARE:<br>(.X) ± (.XXX) ± .010(.3)<br>(.XX) ± .03(.8) ANGLES ± |   | PART NO.<br>CJSK5E88TG** |
| THIRD ANGLE PROJECTION<br>  | DRAWN BY<br>MDJr                        | REVIEW DRAWING NUMBERS   |
| DATE<br>10-22-08   | DRAWING NO.<br>03011-59<br>SHEET 2 OF 2 |                          |
| CHK'D<br>BMBA  |   |                          |